

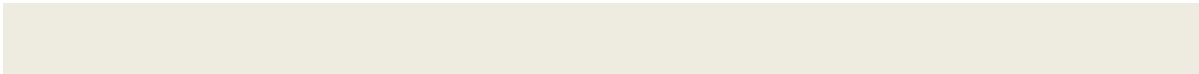

DG H LDI G C ., L D.



C . D D D A

**DG H LDI G C ., L D.**

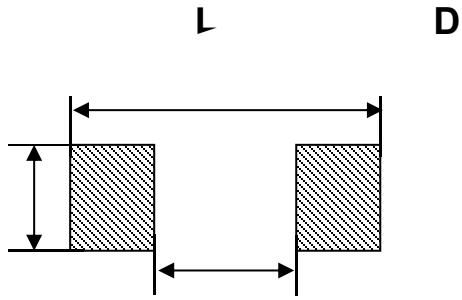

- 
- 

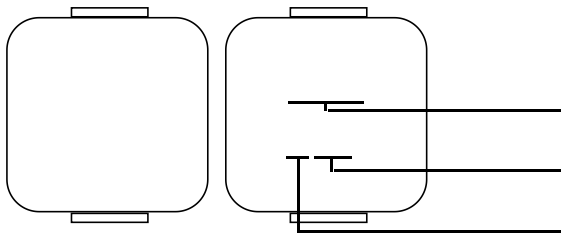

	I		DC ( )		C	H
					I (A .)	I (A .)
	$\mu$					

:

I

. DC C

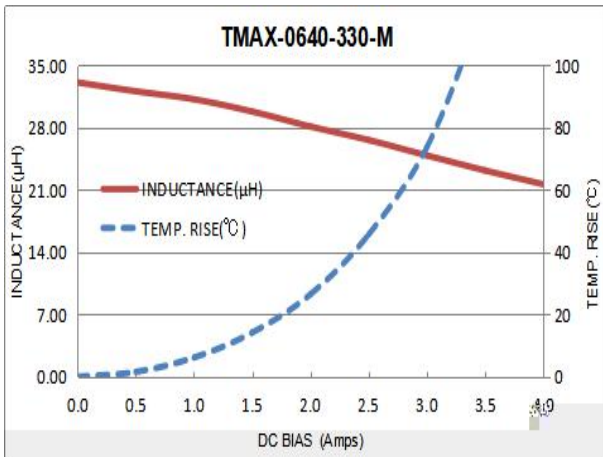
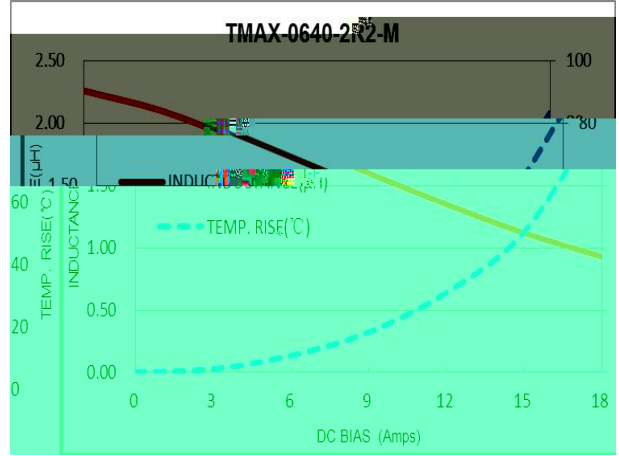
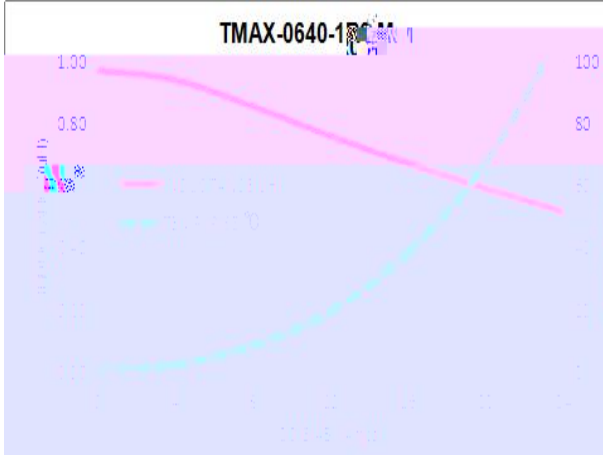

:

|

±

±

±

±

:

I		
	$\begin{matrix} \pm & \pm & \rightarrow \\ & & \rightarrow \pm \\ \pm & \rightarrow & \end{matrix}$	
	$\pm$	$\pm$
	$\pm$	
	$\pm$	
	$\pm$	

**D**

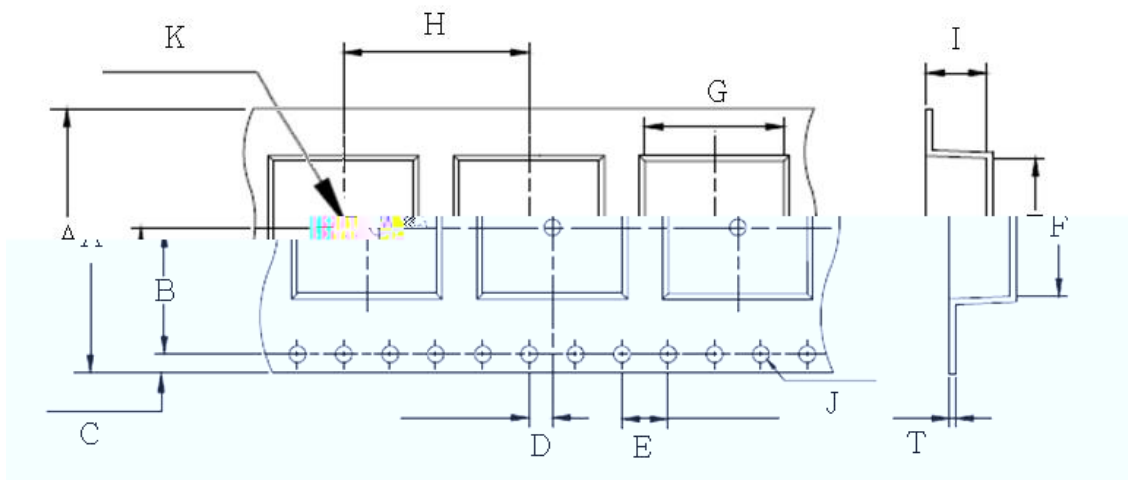

±	±	±	±	±	±
±	±	±	±	±	±

**D**

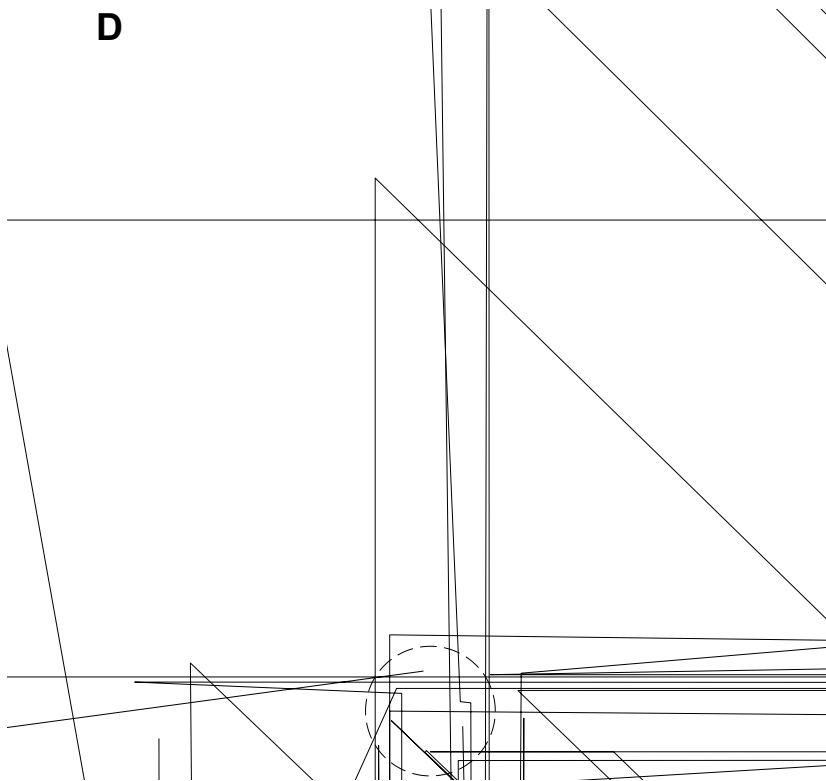

±	±	

- 
- 

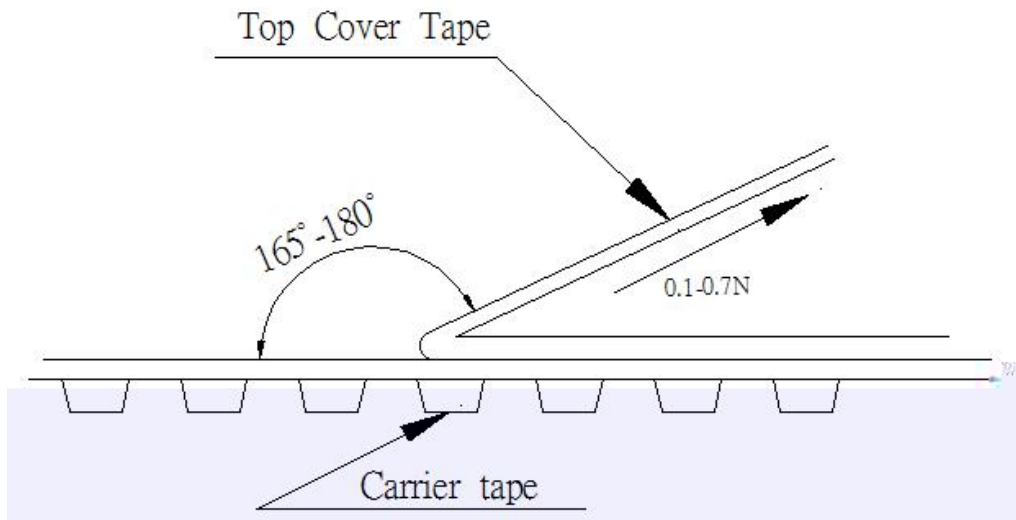





●

L

●

●

L

L

✓

✓

✓

✓

✓

✓

✓

✓

✓

✓

C

C

➤

➤

✓

✓

✓

✓

➤

➤

D

**C**

➤

➤

➤

➤

➤

➤

➤