



**Features**

- 
- 
- 
- 
- 
- 

□

**Applications**

- 

# oms





**TDG HOLDING CO., LTD.**

---

**Notes:**

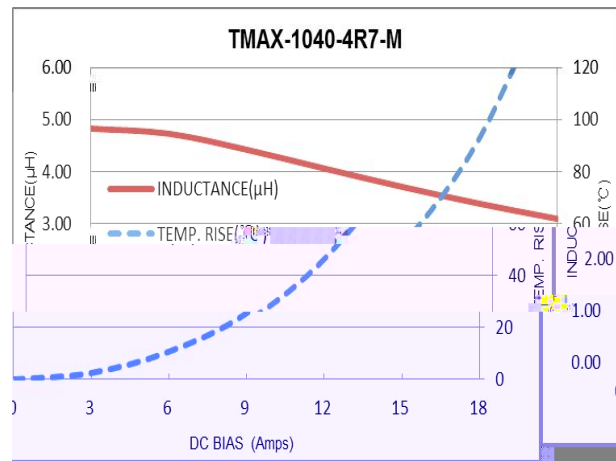
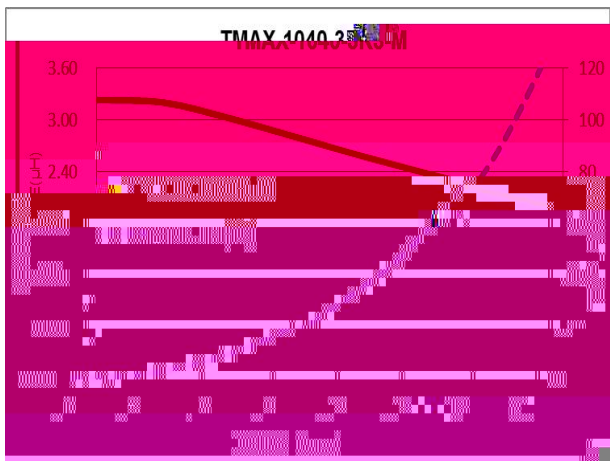
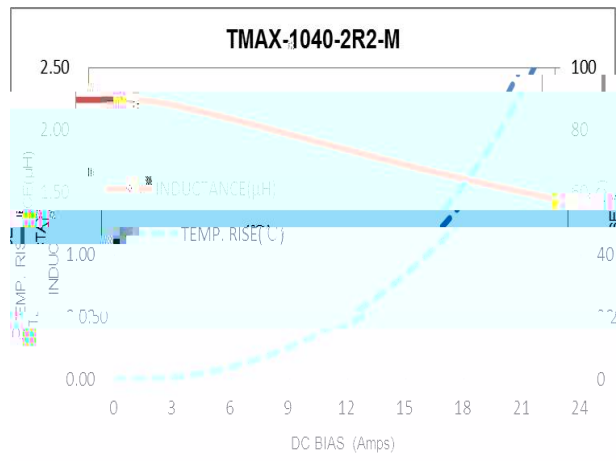
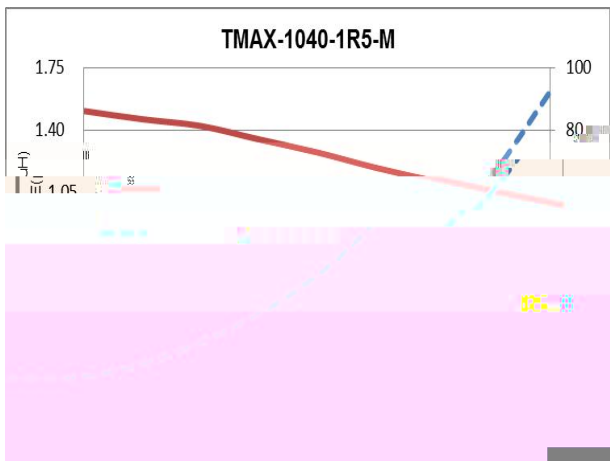
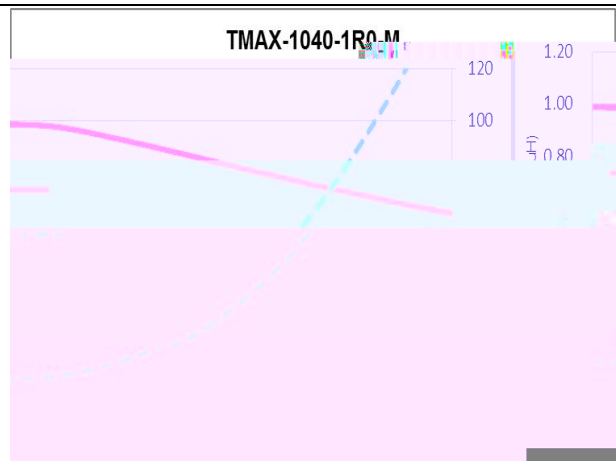
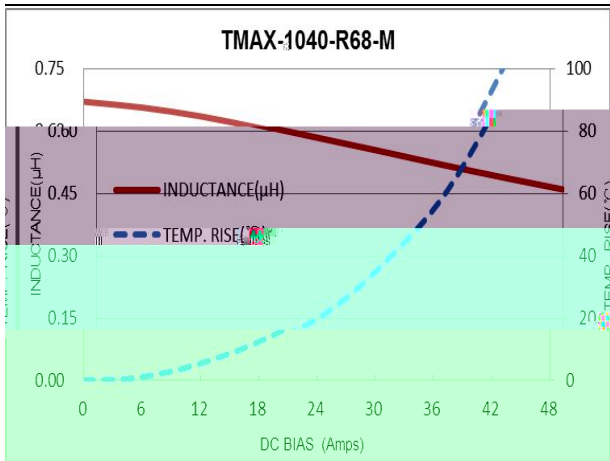

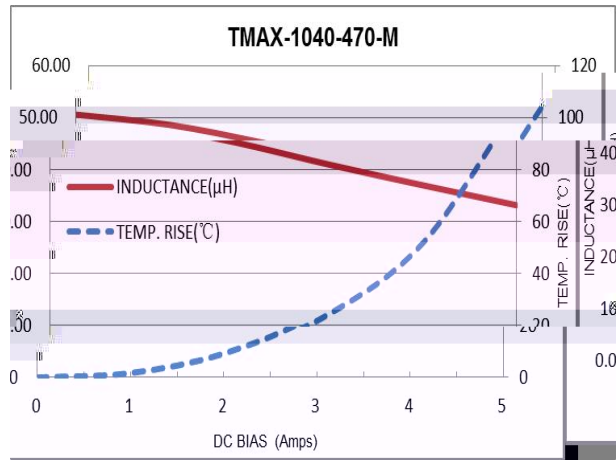
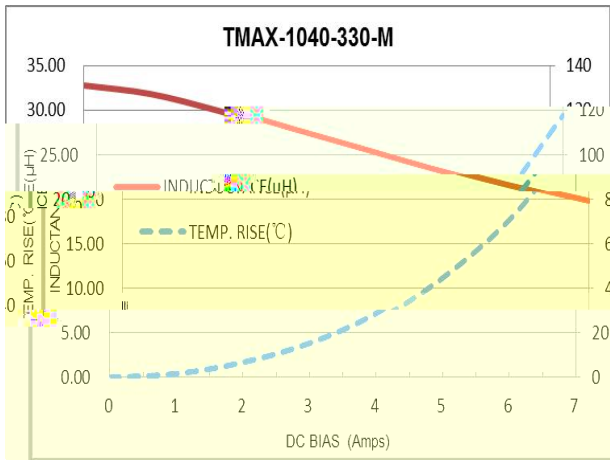
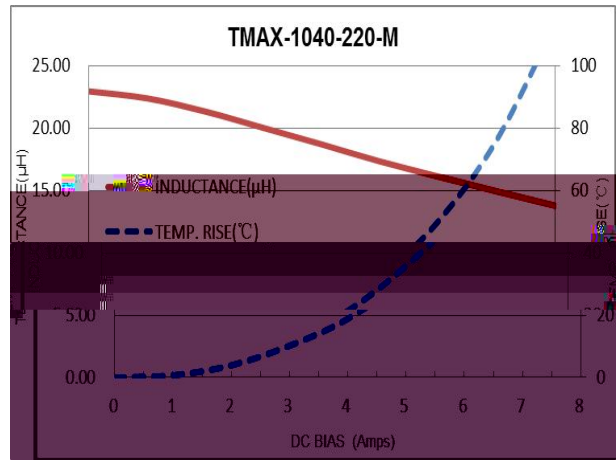
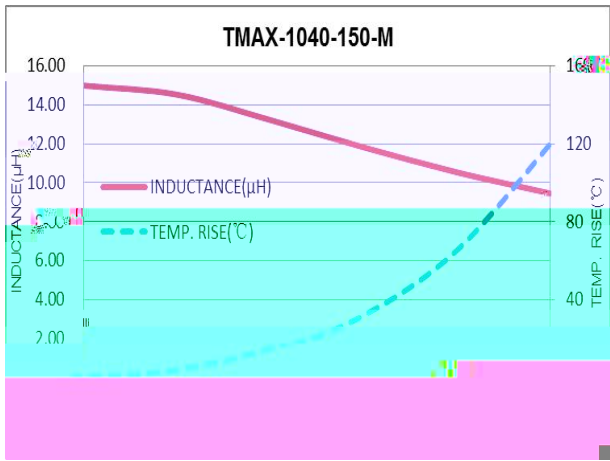
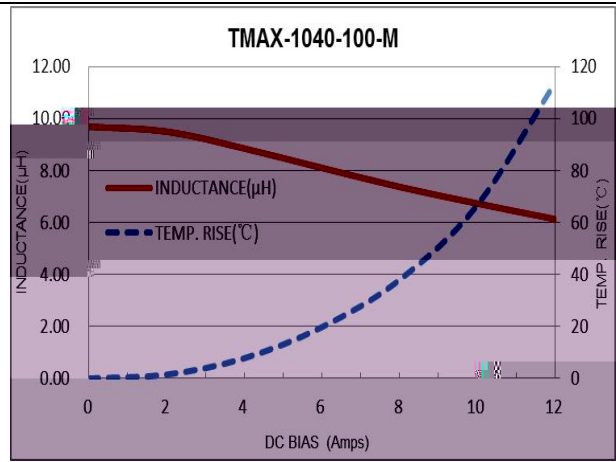
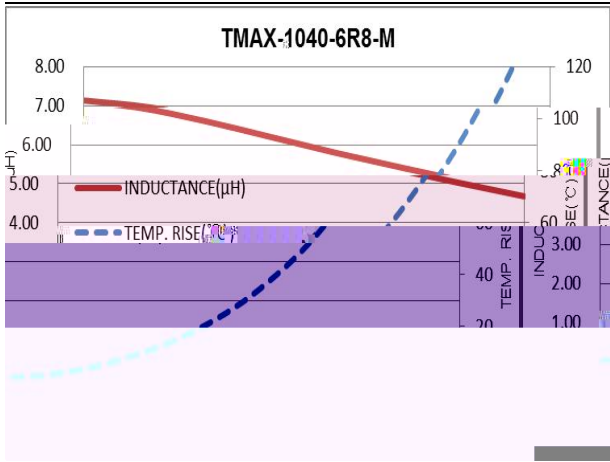





**Reliability:**

Item	Test Method	Specification and Requirement
	$\pm$ $\pm$ $\pm$	
		$\pm$



**Reliability:**

Item	Test Method	Specification and Requirement
	$\pm$ $\pm$ $\rightarrow$ $\rightarrow$ $\pm$ $\pm$ $\rightarrow$	$\pm$
	$\pm$	
	$\pm$	
	$\pm$	
	$\pm$	



**TDG HOLDING CO., LTD.**

---

**Packaging Dimensions**

---

**Peeling of top cover tape**

- 
- 

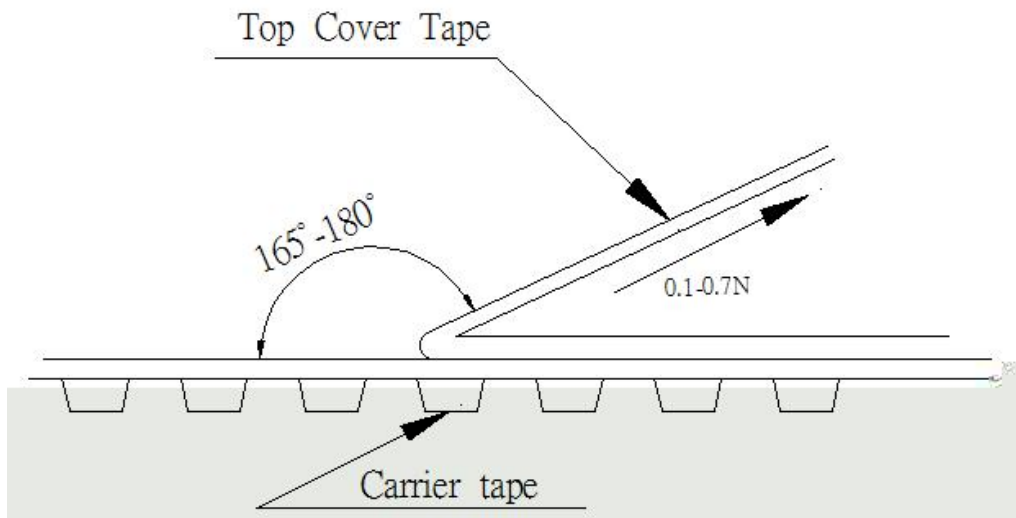



**Numbers of taping**

- 

**Label marking**

- 
- 

**Production Label**

- ✓
- ✓
- ✓
- ✓
- ✓

**Shipping Label**

- ✓
- ✓
- ✓
- ✓
- ✓

**Care note for use****➤ Storage Condition****➤ Use Temperature**

- ✓
- ✓
  
- ✓
- ✓

**➤ Model****➤ Drop**



---

**Care note for Safety**

➤

➤

➤

➤

➤

➤

➤